

# BASO 4.0

## DIRECT/INDIRECT



### Catalog Number Example

BASO 4.0-PDT-BL-OPBW-30K-C80-UNV-010V-SEN-955LF-NLC-ST-96IN

#### A RANGE

BASO 4.0      B A S O 4 . 0

#### B MOUNTING

CS Pendant      P D T

Pendant in-line ACT T-BAR      P A T

Pendant in-line ACT SLOT      P A S

Pendant ACT center tile      P A C

pendant suspension set includes cable suspension and one white power feeder with a white junction box cover

Wall mounted      W A L

for black power feeds or junction box covers, please contact customer service

#### C COLOR

CS White      W H

CS Black      B L

Gray      G R

Custom color RAL      X X

trimless version available in white only

#### D LENS

HP opal cover direct      O P B W

batwing cover indirect

#### E CCT

2700 K      2 7 K

CS 3000 K      3 0 K

CS 3500 K      3 5 K

4000 K      4 0 K

#### F CRI

CRI > 80      C 8 0

CRI > 90      C 9 0

#### G VOLTAGE

120V / 277V      U N V

#### H DIMMING

CS 0-10V 1%      0 1 0 V

Lutron EcoSystem      L E S 1

Quantum, Vive, GRAFIK Eye, HomeWorks

Power over ethernet      P O E C

consult customer service for compatibility

Custom dimming      X X X X

consult customer service for compatibility

#### I SENSOR (optional)

Integrated Sensor      S E N

consult customer service for sensor request

#### J OUTPUT LM/FT UP

CS 500lm/ft 100% ±      0 5 0 0 L F

CS 750lm/ft 100% ±      0 7 5 0 L F

CS 1000lm/ft 100% ±      1 0 0 0 L F

Custom lm/ft      X X X X L F

custom lumen up to 1400 lm/ft

#### K OUTPUT LM/FT DOWN

CS 500lm/ft ±      0 5 0 0 L F

CS 750lm/ft ±      0 7 5 0 L F

CS 1000lm/ft ±      1 0 0 0 L F

Custom lm/ft      X X X X L F

custom lumen up to 1000 lm/ft

#### L CIRCUIT / EM

CS Single circuit      \*

EMC night light circuit      N L C

EMB available in 4ft and 8ft      E M #

Dual Circuit      D C

\* leave blank

#### M SHAPE / PATTERN

CS Linear / straight      S T

Linear / straight + flex inset      S F

includes 4ft. field-cutable section

L-shape      L S

□-shape (rectangular shape)      R S

U-shape      U S

Custom shape      X X

#### N DIMENSIONS IN INCH

CS Linear 4'      4 8 I N

CS Linear 6'      7 2 I N

CS Linear 8'      9 6 I N

Linear custom      # # # I N

Linear flex inset      # # # I N

includes 4' to 3' field-cutable section

L-Shape      # # # X # # # I N

U-Shape      # # # X # # # X # # # I N

□-Shape      # # # X # # # I N

for lengths including flex insets, round up to the nearest total foot length

#### O CERTIFICATION (optional)

Red List Approved      R L A

#### PERFORMANCE

- Up to 117lm/W efficiency
- 500 / 955lm/ft
- CRI > 80 & CRI > 90
- Damp rated

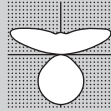

#### MOUNTING

Wall

Pendant

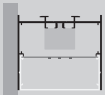

#### PATTERNS



\*X Shapes



Angles



\*Wall to Ceiling



Rectangles



\*T Shapes

For customization, please contact customer service

#### FIELD-CUTTABLE FLEX

Down to 1/16"



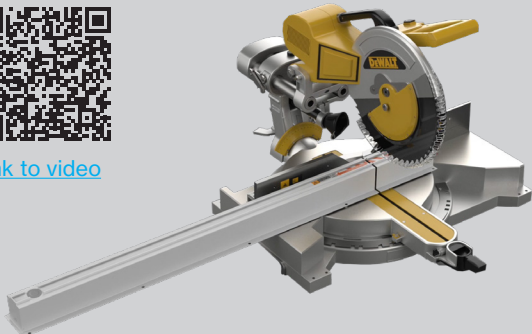

[link to video](#)



**BASO**  
basolighting.com  
xalusa.com

### Technical data

|   | SIZE TYPE      | LED COLOR TEMPERATURE | INPUT WATTS | DELIVERED LM TOTAL | LIGHT DISTRIBUTION | DELIVERED LM DIRECT | DELIVERED LM INDIRECT | OPTICAL EFFICIENCY | LUMINAIRE EFFICACY |
|---|----------------|-----------------------|-------------|--------------------|--------------------|---------------------|-----------------------|--------------------|--------------------|
| <b>BASO DIRECT / INDIRECT</b>   |                |                       |             |                    |                    |                     |                       |                    |                    |
| e LED<br>              | 4' linear      | 40K                   | 17.5 W      | 2060 lm            | 40% down / 60% up  | 215 lm/ft           | 300 lm/ft             | 73%                | 117 lm/W           |
|   | 8' linear      |                       | 35 W        | 4120 lm            |                    |                     |                       |                    |                    |
|   | 2' + 2' corner |                       | 17.5 W      | 2060 lm            |                    |                     |                       |                    |                    |
| e <sup>2</sup> LED<br> | 4' linear      | 40K                   | 33.8 W      | 3850 lm            | 40% down / 60% up  | 407 lm/ft           | 555 lm/ft             | 73%                | 113 lm/W           |
|   | 8' linear      |                       | 67.7 W      | 7690 lm            |                    |                     |                       |                    |                    |
|   | 2' + 2' corner |                       | 33.8 W      | 3850 lm            |                    |                     |                       |                    |                    |

for 30 K or 35 K multiply lm value by 0.96

### Patterns top view

#### LINEAR

| A    | FIXTURES      | CODE        |
|------|---------------|-------------|
| 48"  | 1 × 4' linear | ST - 0 4 FT |
| 96"  | 1 × 8' linear | ST - 0 8 FT |
| 144" | 3 × 4' linear | ST - 1 2 FT |

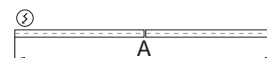

#### L-SHAPE

| A / B     | FIXTURES   | CODE              |
|-----------|--|-------------------|
| 48" / 48" | 2 × 2' linear + 1 × 2' × 2' corner                 | LS - 0 4 X 0 4 FT |
| 48" / 96" | 1 × 2' linear + 1 × 6' linear + 1 × 2' × 2' corner | LS - 0 4 X 0 8 FT |
| 96" / 96" | 2 × 6' linear + 1 × 2' × 2' corner                 | LS - 0 8 X 0 8 FT |

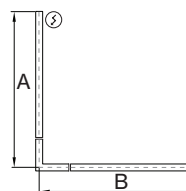

#### □-SHAPE (rectangular shape)

| A / B     | FIXTURES                           | CODE              |
|-----------|------------------------------------|-------------------|
| 48" / 48" | 4 × 2' × 2' corner                 | RS - 0 4 X 0 4 FT |
| 48" / 96" | 2 × 4' linear + 4 × 2' × 2' corner | RS - 0 4 X 0 8 FT |
| 96" / 96" | 4 × 4' linear + 4 × 2' × 2' corner | RS - 0 8 X 0 8 FT |

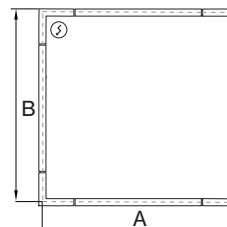

#### U-SHAPE

| A / B / C        | FIXTURES   | CODE                    |
|------------------|--|-------------------------|
| 48" / 48" / 48"  | 2 × 2' linear + 2 × 2' × 2' corner                 | US - 0 4 X 0 4 X 0 4 FT |
| 48" / 96" / 48"  | 1 × 4' linear + 2 × 2' linear + 2 × 2' × 2' corner | US - 0 4 X 0 8 X 0 4 FT |
| 48" / 144" / 48" | 1 × 8' linear + 2 × 2' linear + 2 × 2' × 2' corner | US - 0 4 X 1 2 X 0 4 FT |

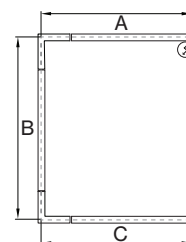

DIMENSIONS

**BASO 4.0**

PENDANT direct

direct / indirect

linear 4ft / 8ft

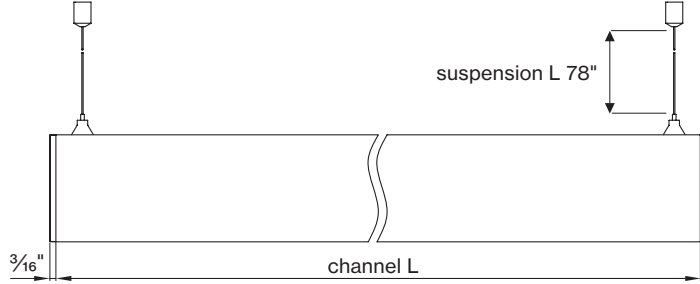
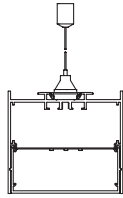
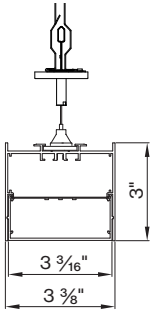

**BASO 4.0 SPECIALITY MOUNTING**

PENDANT ACT TBAR

PENDANT in-line ACT SLOT

PENDANT ACT center tile

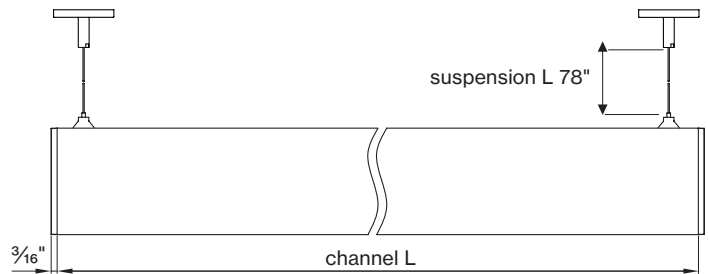
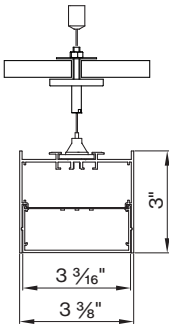
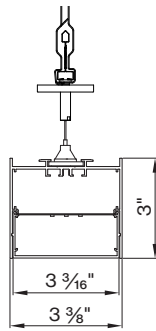
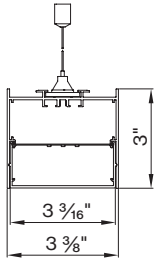

**Declare.**

**BASO 1.5 2.5 4.0**  
**XAL USA Incorporated**

Final Assembly: Collins, Connecticut, USA  
 LBC (Declare's brand)  
 End of Life Options: Recyclable (70%), Landfill (30%)

**Ingredients:**  
 Aluminum, 2-Phenethyl acrylate, 2-methyl-1-methyl ester, polymer with ethyl 2-cyanobenzoate, steel, manufacture, chemical, copper chloride (CuCl<sub>2</sub>), Polyvinyl Chloride (PVC), Polyethylene Glycol (PEG), Polypropylene Glycol (PPG), Polyethylene Glycol (PEG), Copper, Iron, Tin, Organic Silicones, Zinc

1. LBC Temp Exception RE-003 - Small Electrical Components

**Living Building Challenge Criteria:**

**H1 Red List:**  
 LBC Red List Free:  1. Disposed 100% at 100ppm  
 LBC Red List Approved:  VOC Content: Not Applicable  
 Recycled:

**H2 Interior Performance:** Not Applicable  
**H3 Responsible Sourcing:** Not Applicable

XAL-0002  
 03/12/2024  
 Original Issue Date: 2023

INTERNATIONAL LIVING FUTURE INITIATIVE | [www.livingbuildingchallenge.com](http://www.livingbuildingchallenge.com)

**BASO mounting instructions**

Get access to the BASO 4.0 mounting instructions faster by scanning the QR code.

[www.xalusa.com/resources/mounting-instructions/baso](http://www.xalusa.com/resources/mounting-instructions/baso)

